

CARACTERISTIQUES DES SERVOMOTEURS LX NX

AVEC SERVOAMPLIFICATEURS DIGIVEX 230V

Type MOTEUR	Calibre DIGIVEX	Couple en rotation lente	Vitesse maximale	Inertie	Couple par ampère crête	Courant permanent
		(Mo) N.m	(N) rpm	(J) kgm ² .10 ⁻⁵	(Kt) N.m/Â	(Îo) Â
LX210BW	2/4	0,28	6500	1,8	0,216	1,3
*LX220BT	2/4	0,58	6200	3,3	0,332	1,75
NX310EAP	2/4	2	2300	7,9	1	2
NX310EAK	4/8		4000		0,574	3,49
NX420EAP	4/8	4	2300	29	1	3,98
NX420EAJ	7.5/15		4000		0,58	6,9
NX430EAJ	7.5/15	5,5	3200	42,6	0,742	7,41
NX430EAF	15/30		4000		0,586	9,39
NX620EAR	7.5/15	8	2200	98	1,07	7,5
NX620EAJ	15/30		4000		0,572	14
NX630EAR	7.5/15	12	1450	147	1,5	8
NX630EAK	15/30		2800		0,799	15
NX630EAG	30/60		4000		0,565	21,2
LX820DH	30/60	19	2800	230	0,688	27,6
LX820DF	60/100		3800		0,516	36,8
LX840DG	30/60	38	1600	420	1,28	29,6
LX840DE	60/100		2200		0,918	41,4
**LX820VK	30/60	28	2000	230	0,94	29,8
**LX820VF	60/100		3800		0,512	54,6
**LX840VE	60/100	54	2200	420	0,904	59,7

* MOTEUR "GENÉRIQUE". En l'absence d'information à la commande, chaque calibre de DIGIVEX est configuré pour le moteur dit "générique".

** Moteur ventilé.

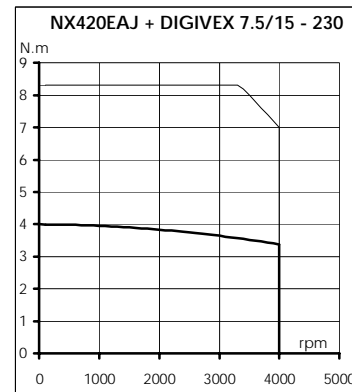
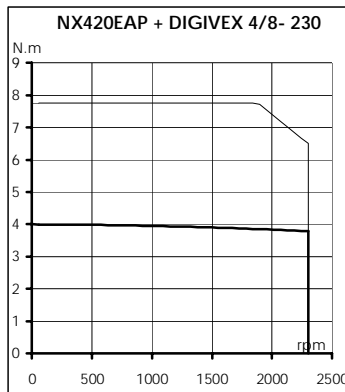
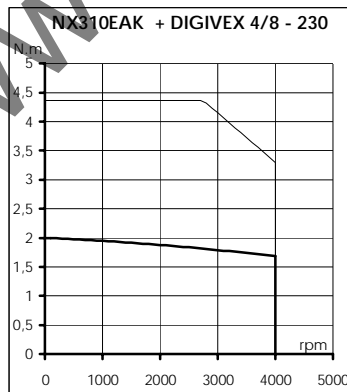
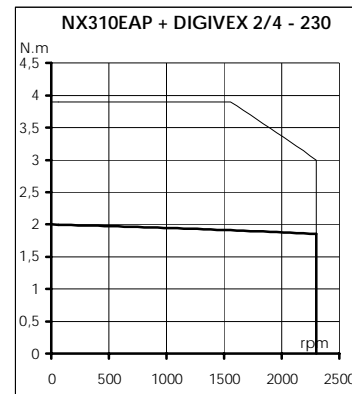
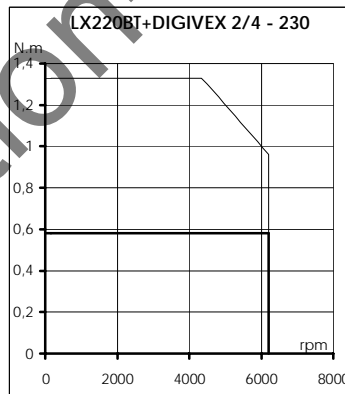
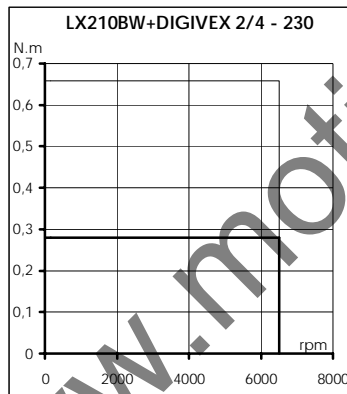

— Impulsionnel
— Permanent

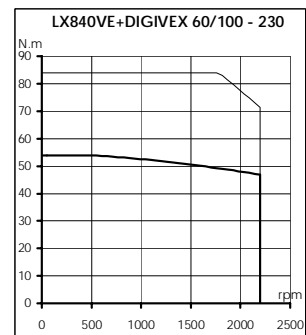
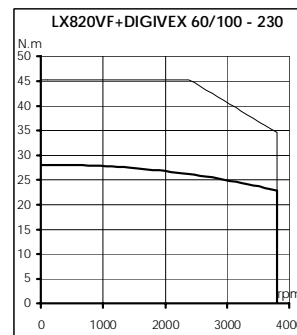
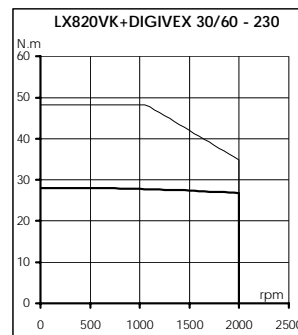
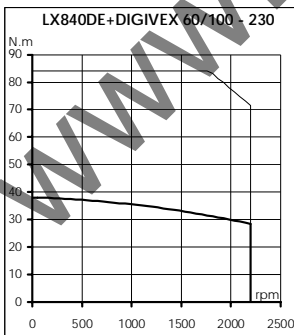
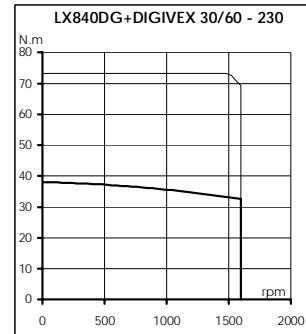
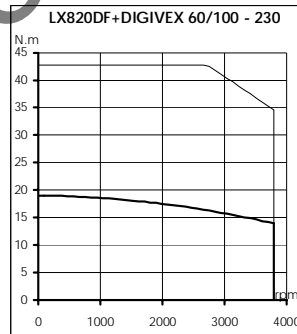
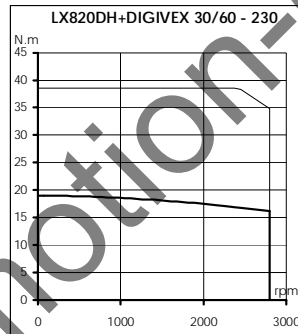
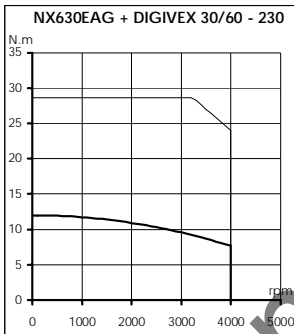
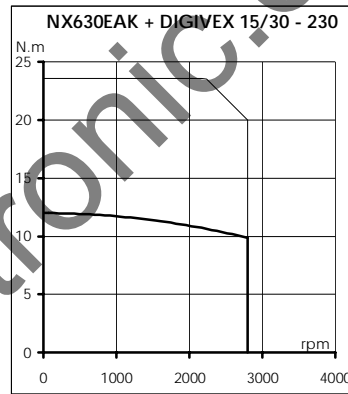
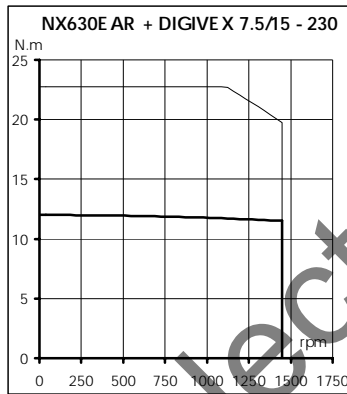
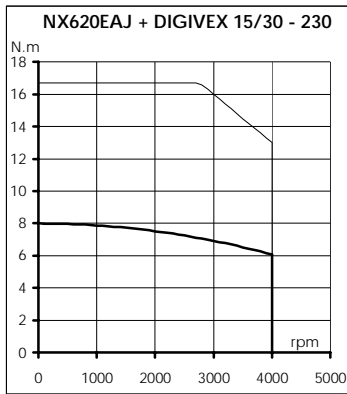
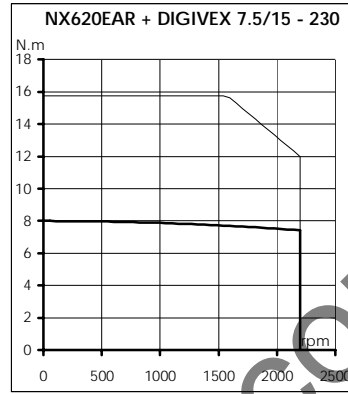
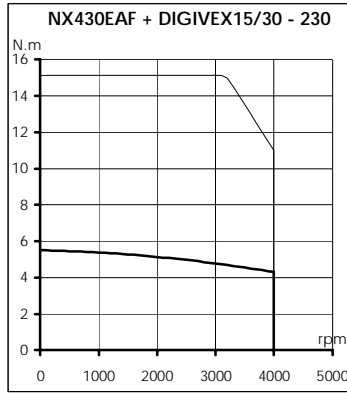
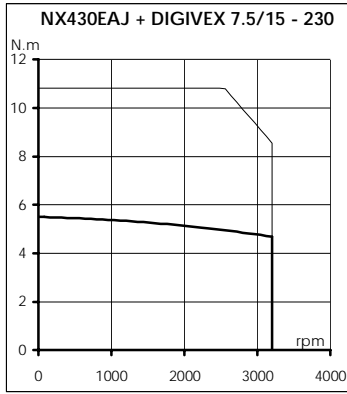

— Impulsionnel
 — Permanent

LX - NX

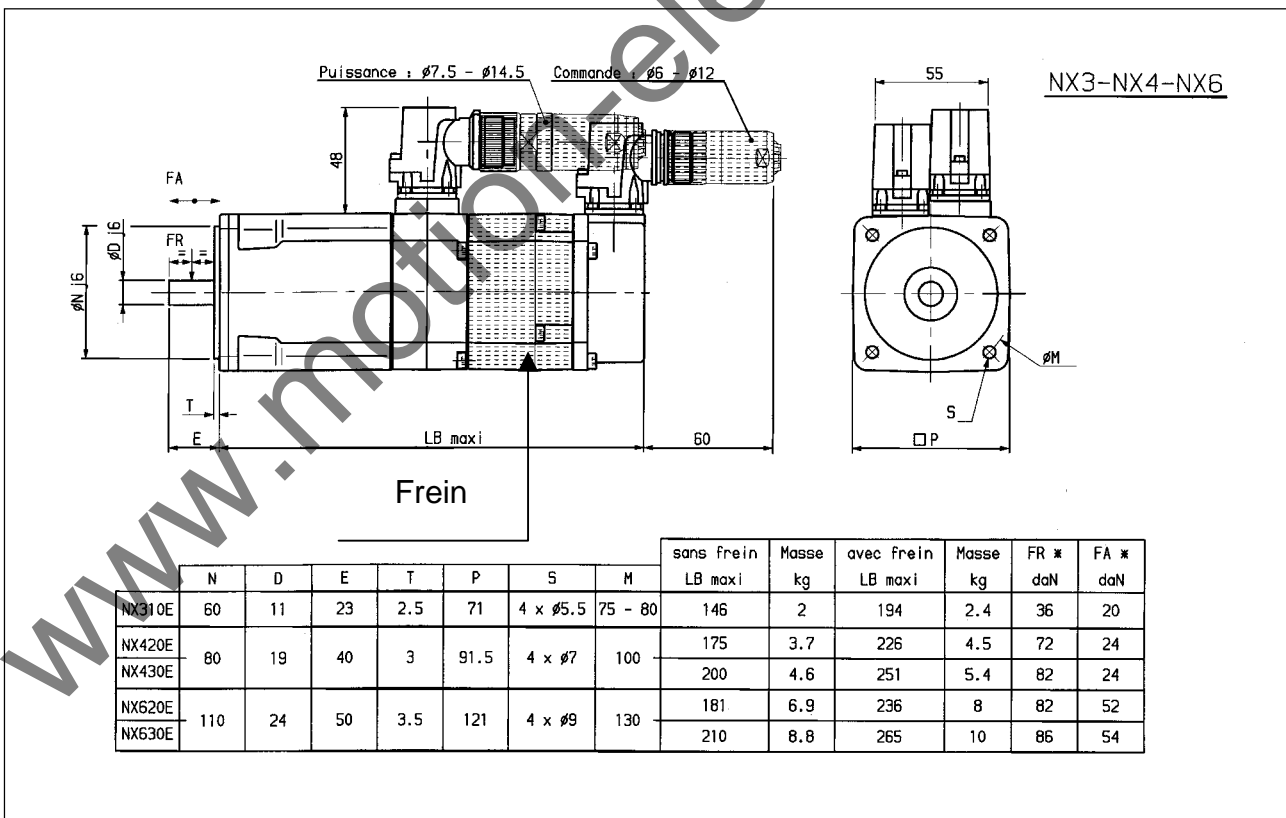
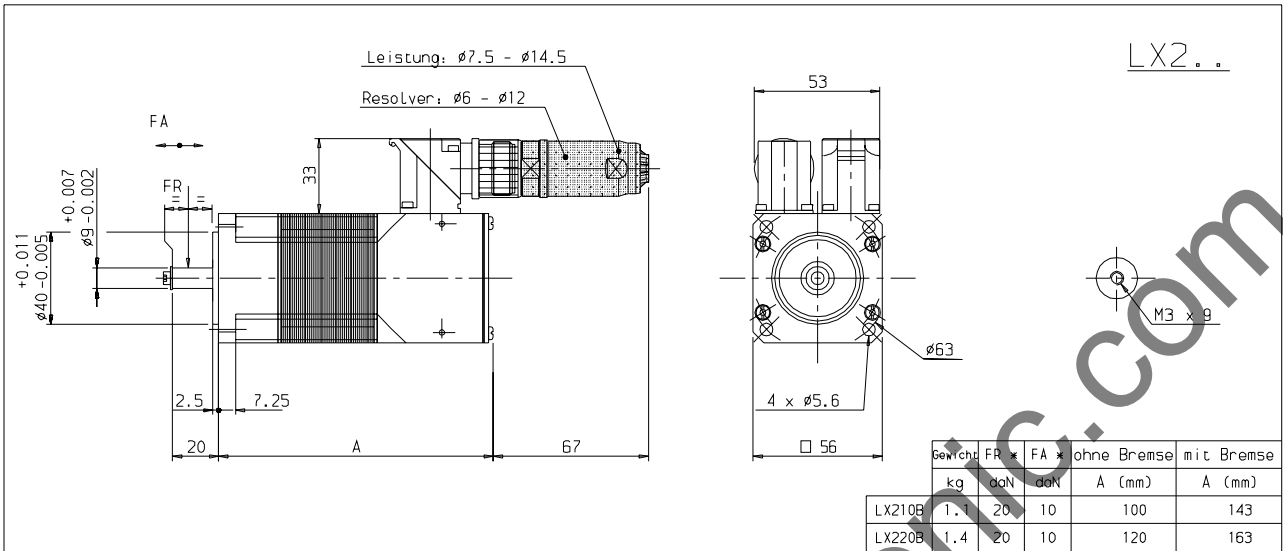

option
 FA et FR non cumulables

* Vitesse : 3000 min⁻¹